











Courchevel

FREESTANDING ELECTRIC STOVE

CVL20E



Features

-  Unique Optiflame effect
-  2kW heat output
-  Choice of 2 heat settings
-  Thermostat
-  Downlight
-  LED lighting
-  Remote control
-  Log effect fuel bed
-  Flame effect only
-  Opening door

Courchevel



Remote Control

- On/off



Logs

Courchevel

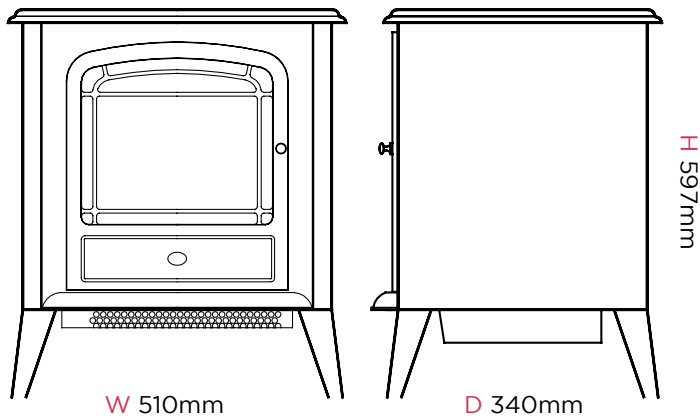

Dimensions & Weight

Height (mm)	Width (mm)	Depth (mm)	Weight (kg)
597	510	340	16.7

Product Features

Heat Output	2kW
Heat Settings	2 - 1kW / 2kW
Variable Thermostat	Y
Fan Heat / Radiant Heat	Yes / No
Location of Controls	Right Side - Bottom
On/Off Switch	Y
Remote Control	Y
Batteries Included	Y - CR2032
Optiflame Effect	Y
Flame Type	Optiflame
Flame Effect Only	Y
Fuel Bed Supplied	Logs

Accessories

HPD001 Hearth Pad	X-025951
-------------------	----------

Product Features

Product Category	Electric Fires
Product Type	Stove
Brand	Dimplex
Model/Range Name	Courchevel
Flame Effect	Optiflame
Model Reference	CVL20E
Material Code	X-061461
Barcode	5011139061461
Commodity Code	8516299100
Country of Origin	PRC
Approvals	UKCA, BEAB
Guarantee Period	1 year

Product Features

Lot 20 Compliant	Y
Freestanding	Y
Wall Mountable	N
Inset	N
Opening Door	Y
Suite	N
Lamp Type	LED
Kettle (IEC) Lead	N
Safety Cut Out	Y
Power Cord Length	1.8m
Core Materials	MDF / Metal / Plastic
Finish / Colour	White